



---

# Mains Restraining Clamp 180-250mm

---

## Operating Instructions

---

REVISION: 01



# Helping you make the right connections.

© **Copyright Caldervale Technology Ltd.**

The copyright for this product and instruction manual is held by Caldervale Technology Ltd. Any technical specifications, or illustrations part of this manual cannot be reproduced, used illicitly or distributed in any form for competitive purposes.

<b>Contents</b>	Page
01. Introduction	02
02. Safety Instructions	03
03. Bases	04
04. Reduction Liners	05
05. Operation	06
06. Specifications	09
07. Parts Diagram	10
08. Warranty Information	11
09. Service and Repair	13
10. Decommissioning and Disposal	13
Certificate of Conformity	14

# 01. Introduction

---

## General Description

The pipe positioning tool is designed to restrain the movement pipe (new, weathered or previously installed) for the fitment of couplers, elbows and reducers they are designed to fit pipes of sizes up to 250mm and hold pipe steady for electrofusion welding.

The clamps have interchangeable shells allowing quick and easy access for any size coupler or reducer.

This product (250 Mains Restraining Clamp) has been manufactured, inspected and tested in accordance with the ISO9001 quality control systems and procedures in place at Caldervale Technology Ltd, Dewsbury.

---

**This unit is designed and manufactured to meet the requirements of National Grid Gas Industry Standards GIS/PL2-5 Part 5 Electrofusion ancillary tooling.**



## Important!

It is important to ensure all component parts are present and in serviceable condition.

This tool should be used in accordance with the pipe manufacturers' recommendations and in line with local codes of practice.

This manual outlines the operation of the pipe positioning tool and forms a part of the product to which it relates. It should be kept for the life of the product. Any amendments issued by Caldervale Technology Ltd should be incorporated in the text. The manual should be passed to any subsequent holder or user of this product.

## 02. Safety Instructions

---

1. Read and understand the whole booklet before using the tool.
2. It is imperative that all possible precautions are made to avoid unexpected movement of the tool and pipe during use.
3. Never attempt to operate on pipes that are not within the specified dimensions.
4. Operatives should wear eye protection, gloves, safety headwear & footwear when using the equipment.

## 03. Bases

A selection of bases are available for the 250mm mains clamp. Different bases aid in making different styles of joint, such as a Tee joint. Below is a table of our bases, these do not include clamps.

Product Code	Description
01-16-110	750mm three-way adaptor only
01-08-240	750mm straight base only
01-16-106	Angle maker base only

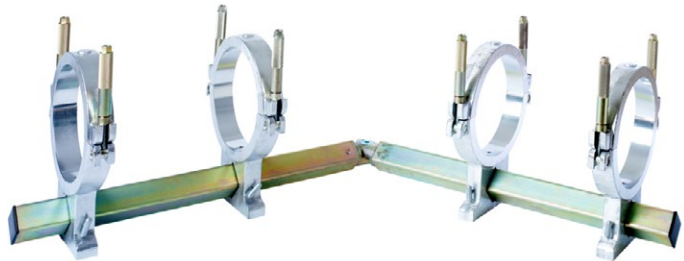

**Mains Restraining Clamp with Angle Maker**  
01-15-026

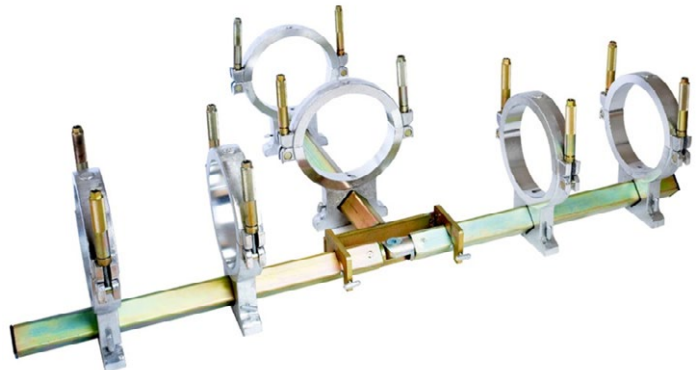

**Mains Restraining Clamp with 3 Way Clamping**  
01-15-017

## 04. Reduction Liners

Reduction liners allow the clamping tool to be used on multiple sizes of pipe rather than just one size, allowing for more flexibility and correct clamping of many sizes.

Below is a list of our most commonly requested reduction liners for this clamp; other sizes are available upon request:

Product Code	Description
01-15-301	250-225mm shells (2pcs)
01-15-302	250-200mm shells (2pcs)
01-15-303	250-180mm shells (2pcs)
01-15-304	250-225mm shells (4pcs)
01-15-305	250-200mm shells (4pcs)
01-15-306	250-180mm shells (4pcs)
01-15-307	250-225mm shells (6pcs) for 3 way
01-15-308	250-200mm shells (6pcs) for 3 way



**Reduction Liners Set**

## 05. Operation

Prior to setting up the clamps the appropriate box section base should be selected.

### Instructions for Angle Maker Base

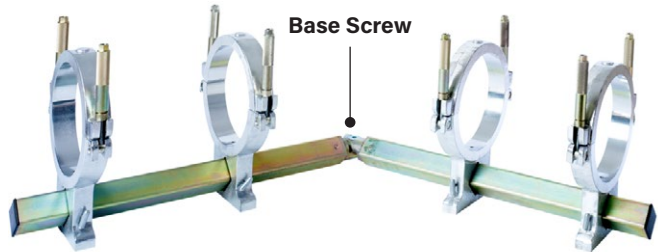

If an angled fitting is required an angle maker base should be used, and for a tee joint a three-way base adapter is available.

The angle maker base should be set up by:

1. First unscrewing the base screw with the provided Allen key.
2. Mate the ends of the bases at the appropriate angle and replace the countersunk screw and tighten it until the base pieces do not move separately.

### Instructions for 3 Way Adapter

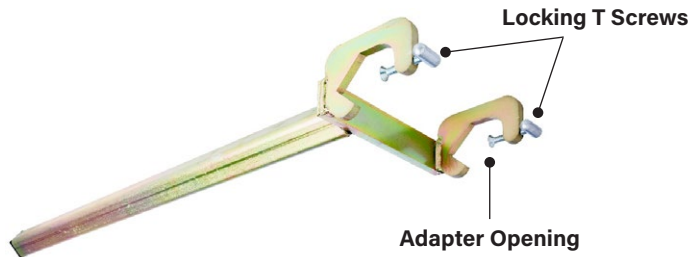

The 3 way adapter is an attachment that can be used in conjunction with any other base and is designed to attach to another base to give an extra base perpendicular to the base which it is attached.



This is attached to any other base as follows:

1. Ensure the three-way adapters locking T screws are turned anticlockwise fully.
2. The opening of the adapter should then be placed over the base to which it will be attached.
3. The locking T screws should be tightened by turning clockwise until they are both tight on the other base.

The 3 way adapter is now ready to accept clamps.

## Instructions for Clamps

### Clamping Screws

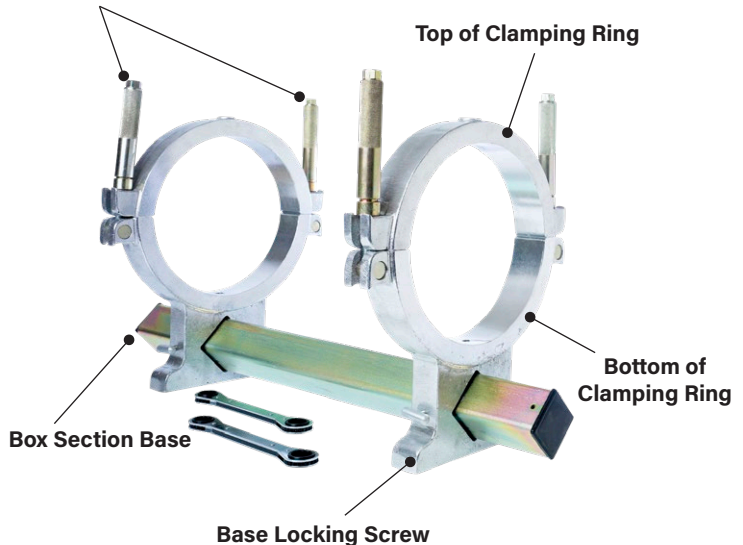

1. Turn the clamping screws anti clockwise to release the top of the clamping ring.
2. Set the reduction liners to suit the pipe to be clamped (using the provided Allen key unscrew any shells already in the clamp).
3. Insert the required reduction liners fixing them in place using the Allen key provided.

4. Repeat above for any further rings to be used
5. Select the appropriate box section base for the joint (straight, angle maker or three way, see page 4)
6. Insert the base selected into the diamond cut out in the bottom of the clamping rings to be used
7. When the bottom of the clamp ring is in the correct/preferred position turn the base locking screw clockwise to allow the bottom of the clamp ring to be fixed in place
8. The pipe to be clamped can now be inserted into the clamps and the top of the clamping ring reattached using the clamping screws
9. The clamping screws should be tightened to ensure the pipe cannot move relative to the clamping system.

## Removal

1. On completion of the jointing and cooling cycle, the clamp may be removed by releasing the Clamping screws, opening the clamp rings and lifting free.
2. Turn base locking screws anti-clockwise to release clamp from the box section base.



## Storage

### **IMPORTANT! When not in use always:**

1. Store the tool in the carry case provided.
2. Ensure the tool is clean and dry before storage.

## 06. Specifications

<b>Materials:</b>	Mild Steel EN1A, Mild Steel EN3A, Stainless Steel, Brass, Aluminium
<b>Finish:</b>	Natural / Anodised (Aluminium) / Zinc passivate to mild steel parts
<b>Pipe Range:</b>	180mm to 250mm All SDR Ratings

Product Code	Dimensions	Weight
<b>01-15-090</b> Mains restraining clamp 250-225-200-180mm nylon shells, straight base	1050 x 450 x 120mm	23.5kg
<b>01-15-091</b> Mains restraining clamp 250-225-200-180mm nylon shells, angle maker	775 x 500 x 120mm	30kg
<b>01-15-092</b> Mains restraining clamp 250-225-200-180mm nylon shells 3-way PM	800 x 600 x 120mm	30kg
<b>01-15-093</b> Mains restraining clamp 'Double' 250-225-200-180mm nylon shells, straight base	1050 x 500 x 220mm	36kg
<b>01-15-094</b> Mains restraining clamp 'Double' 250-225-200-180mm nylon shells, angle maker	775 x 500 x 220mm	43kg
<b>01-15-095</b> Mains restraining clamp 'Double' 250-225-200-180mm nylon shells 3-way PM	800 x 600 x 220mm	69kg
<b>01-15-096</b> Mains restraining clamp ring only	480 x 365 x 50mm	6.2kg

All measurements above are approximate and do not account for any packaging, bags or boxes.

This unit is designed and manufactured to meet the requirements of National Grid Gas Industry Standards GIS/PL2-5 Part 5 Electrofusion and Ancillary Tooling.

Caldervale Technology Ltd has a policy of continuous improvement in product quality and design. Caldervale Technology Ltd therefore reserves the right to change the specification of its models at any time, without prior notice.

**It is the responsibility of the operator to ensure that the PE pipe is suitable for this clamping system if in doubt contact the PE pipe manufacturer for confirmation.**

## 07. Parts Diagram

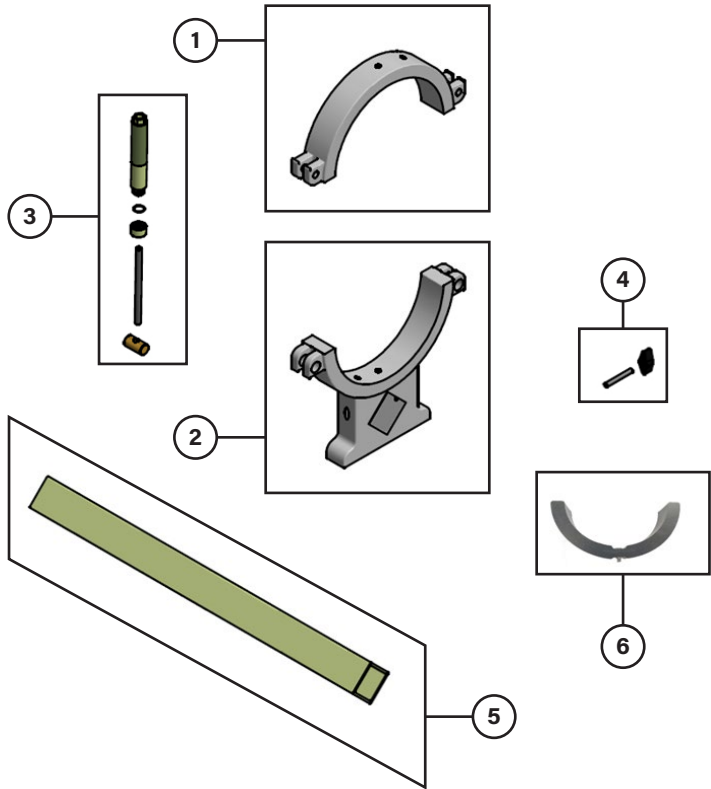

Part	Product Code	Description
1	TBC	Mains Clamp (250mm) Clamp Top
2	TBC	Mains Clamp (250mm) Clamp Bottom
3	TBC	Mains Clamp (250mm) Clamping Screw
4	TBC	Mains Clamp (250mm) Base Locking Screw
5	See Page 04	Spare Box Section Base
6	See page 05	Reducing shells

## 08. Warranty Information

---

### 1. Extent of Warranty

- a) Subject to clauses 2 and 3, Caldervale Technology Ltd warrants to the end-user customer that its products will be free from defects in materials and workmanship, for six months after the date of purchase by the end-user customer, subject to providing proof of purchase.
- b) If Caldervale Technology Ltd receives, during the warranty period, notice of a defect in product which is covered by this warranty; Caldervale Technology Ltd shall either repair or replace the product, at its option. Any replacement product may be either new or like-new, provided that it has functionality at least equal to that of the product being replaced.
- c) All warranty work will be carried out by Caldervale Technology Ltd unless otherwise agreed. On-site warranty and repair or replacement services are available from authorised Caldervale Technology Ltd service facilities world-wide.
- d) Customers shall prepay shipping charges for products returned to Caldervale Technology Ltd for warranty service, and Caldervale Technology Ltd will charge for return of the products back to the customer.
- e) This warranty statement gives the customer specific legal rights. The customer may also have other rights which vary from country to country in the world.

### 2. Pre-conditions for Warranty Application

Caldervale Technology Ltd's warranty covers only those defects which arise as a result of normal use of the product, and this warranty shall only apply in the following circumstances:

- a) All the instructions contained in the operating manual have been complied with; and
- b) None of the following apply:
  - i) Improper or inadequate maintenance;
  - ii) Physical abuse;
  - iii) Unauthorised modification, misuse or any use not in accordance with the operating manual and good industry practice;

- iv) Operation outside the products specifications;
- v) Improper site preparation or maintenance;
- vi) Faulty pipes.

### 3. Limitations of Warranty

- a) Caldervale Technology Ltd does not warrant the operation of any product to be uninterrupted or error free.
- b) Caldervale Technology Ltd makes no other warranty of any kind, whether express or implied, with respect to its products. Caldervale Technology Ltd specifically disclaims the implied warranties of satisfactory quality and fitness for a particular purpose.
- c) To the extent that this warranty statement is inconsistent with the law of the locality where the customer uses the product, this warranty statement shall be deemed modified by the minimum necessary to be consistent with such local law.
- d) To the extent allowed by local law, the remedies provided in this warranty statement are the customer's sole and exclusive remedies.
- e) This tool has been designed for the range of pipes available at the time of its design and development. Caldervale Technology Ltd can accept NO liability for the unit's ability or otherwise to work with new or different pipes that subsequently appear in the market place.

---

**Please complete this information and keep it safely with your proof of purchase receipt. You will require it for any warranty claim.**

Where purchased: \_\_\_\_\_

Date of purchase: \_\_\_\_\_

Name of purchaser: \_\_\_\_\_

Address of purchaser: \_\_\_\_\_

\_\_\_\_\_

\_\_\_\_\_

Type of tool: \_\_\_\_\_

Serial number: \_\_\_\_\_

## 09. Service and Repair

---

This product has no specific calibration period, however periodic safety inspections should be carried out by the operator as specified in this manual, if in any doubt please contact the manufacturer for further information.

### INTERNATIONAL

#### **Caldervale Technology Ltd**

Bretfield Court, Dewsbury,  
West Yorkshire WF12 9BG, UK

T. +44 (0)1924 469571

E. [sales@caldertech.com](mailto:sales@caldertech.com)

W. [caldertech.com](http://caldertech.com)

### AUSTRALIA / NZ

#### **Caldertech Australia Pty Ltd**

Unit 3/30 Juna Drive,  
Malaga WA 6090, Australia

T. +61 (0)8 9209 1132

E. [sales@caldertech.com.au](mailto:sales@caldertech.com.au)

W. [caldertech.com.au](http://caldertech.com.au)

## 10. Decommissioning and Disposal

---

These give the instructions for decommissioning and disposal of the equipment and confirm how it is to be taken out of service safely, in respect of the Essential Environmental, Health and Safety Requirements.

- If a Caldertech Mains Clamp has reached the end of its useful working life and cannot be refurbished it must be sent to a licensed recycling facility for treatment. That will ensure the waste hierarchy requirements are met.
- End of life treatment is the responsibility of the Customer. This can also be achieved by returning the product back to the manufacturer if required.



---

## Certificate of Conformity

---

This document certifies that the product detailed below fully conforms to the following standard without derogation.

---

**GIS/PL2-5:2018 Electrofusion Ancillary Tools**

---

**Product: 250 Mains Restraining Clamp**

---

**MARCH 2019**



---

**I. Smith**  
Managing Director



**Caldervale Technology Ltd**  
Bretfield Court, Dewsbury, West Yorkshire WF12 9BG, UK  
CRN 2769288 | ISO 9001:2015 Certified FM 30989





**INTERNATIONAL**

**Caldervale Technology Ltd**

Bretfield Court, Dewsbury,  
West Yorkshire WF12 9BG, UK

T. +44 (0)1924 469571

E. [sales@caldertech.com](mailto:sales@caldertech.com)

W. [caldertech.com](http://caldertech.com)

---

**AUSTRALIA / NZ**

**Caldertech Australia Pty Ltd**

Unit 3/30 Juna Drive,  
Malaga WA 6090, Australia

T. +61 (0)8 9209 1132

E. [sales@caldertech.com.au](mailto:sales@caldertech.com.au)

W. [caldertech.com.au](http://caldertech.com.au)



**Caldertech**  
**.com**